

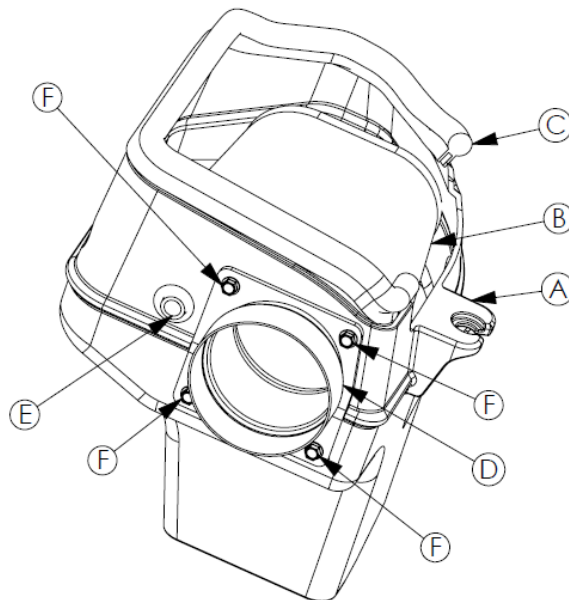

INSTALLATION INSTRUCTIONS
AIR INTAKE KIT
2011-2016 DODGE CHALLENGER 6.4L HEMI
2012-2016 CHRYSLER 300C 6.4L HEMI
2012-2016 DODGE CHARGER 6.4L HEMI
PART NUMBER 77070043AC

Bill of Materials for 77070043AC

A	1	9-0398	MOPAR Air Box
B	1	MP-M-1012	Air Filter Assembly
C	1	102507	Rubber Edge Trim 30-1/2"
D	1	08516	Air Filter Adaptor
E	1	8-171	Hose Adaptor Fitting, 3/4" to 5/8"
F	5	08373	M6 Bolt
Not Shown	1	8-183	Blanking Plug
Not Shown	1	081004	Aluminum Threaded Boss
Not Shown	1	L77070043AB	Instructions





INSTALLATION INSTRUCTIONS
AIR INTAKE KIT
2011-2016 DODGE CHALLENGER 6.4L HEMI
2012-2016 CHRYSLER 300C 6.4L HEMI
2012-2016 DODGE CHARGER 6.4L HEMI
PART NUMBER 77070043AC



IMPORTANT:

This kit includes a high-performance DRYFLOW Air Filter.

DO NOT APPLY ANY OIL TO THIS FILTER! See Step 5 for cleaning instructions.

Read and understand these instructions **BEFORE** attempting to install this product.

1) Getting Started

- a) If engine has run within the past two hours, open the hood and allow it to cool down.
- b) Make sure the vehicle is parked on a level surface.
- c) Set the parking brake.
- d) Disconnect the negative battery terminal.
- e) Open the air intake kit package and make sure all parts are included.

2) Removal of the stock intake system



a) Your stock air intake system should look like this.



b) Loosen the hose clamp securing the air inlet tube to the air box.



INSTALLATION INSTRUCTIONS
AIR INTAKE KIT
2011-2016 DODGE CHALLENGER 6.4L HEMI
2012-2016 CHRYSLER 300C 6.4L HEMI
2012-2016 DODGE CHARGER 6.4L HEMI
PART NUMBER 77070043AC



c) Detach the valve cover breather hose from the air box.

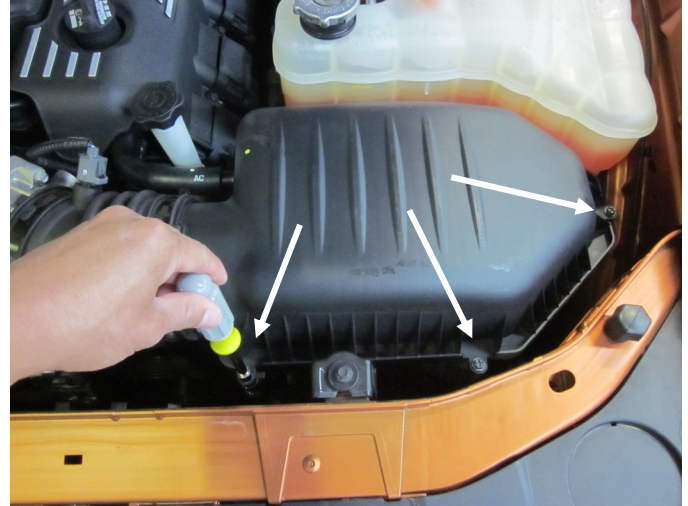

d) Loosen and remove all (3) of the M6 screws securing the air box lid to the base.



e) With the M6 screws removed, un-hinge and remove the air box lid from the air intake hose.



f) Loosen and remove the M6 air box mounting bolt. This bolt will be reused in step 3j).



INSTALLATION INSTRUCTIONS
AIR INTAKE KIT
2011-2016 DODGE CHALLENGER 6.4L HEMI
2012-2016 CHRYSLER 300C 6.4L HEMI
2012-2016 DODGE CHARGER 6.4L HEMI
PART NUMBER 77070043AC

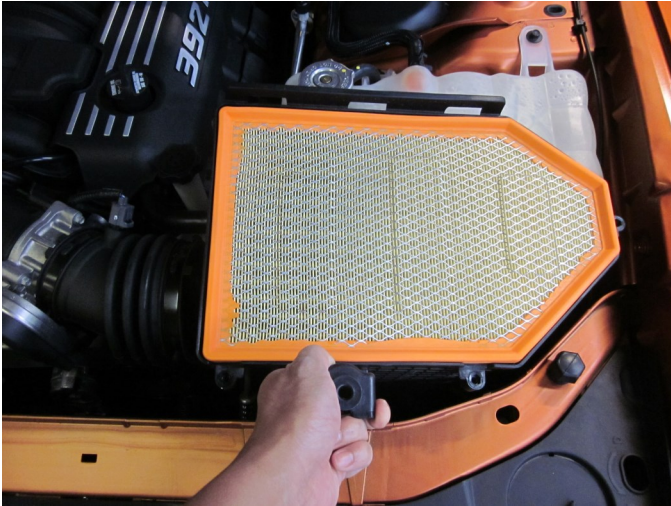

g) Remove the air box base from the engine bay. **Note:** Pull up to release the base from the inner fender.



h) Remove the rubber bushing from the air box base. This will be transferred to the MOPAR air box in step 3b).

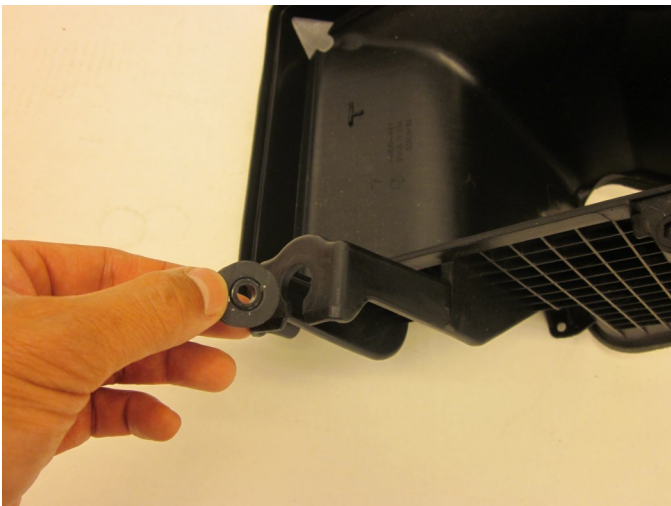

i) Remove the rubber grommet from the air box base. This will be transferred to the MOPAR air box in step 3c).



INSTALLATION INSTRUCTIONS
AIR INTAKE KIT
2011-2016 DODGE CHALLENGER 6.4L HEMI
2012-2016 CHRYSLER 300C 6.4L HEMI
2012-2016 DODGE CHARGER 6.4L HEMI
PART NUMBER 77070043AC

3) Installation of MOPAR Air Intake System

NOTE: When installing the MOPAR Air Intake System, DO NOT completely tighten the hose clamps or mounting hardware until instructed to do so. Check to see that the inside of the inlet tubes and air filter are clean and free from any foreign objects and/or obstructions

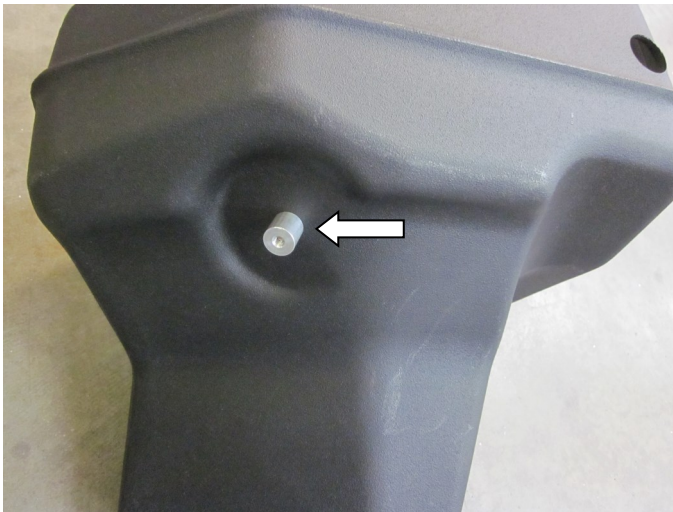

a) Install supplied aluminum threaded boss to the bottom of the MOPAR Air Box with supplied M6 bolt and tighten to 4.0Nm (35.4 in/lb).

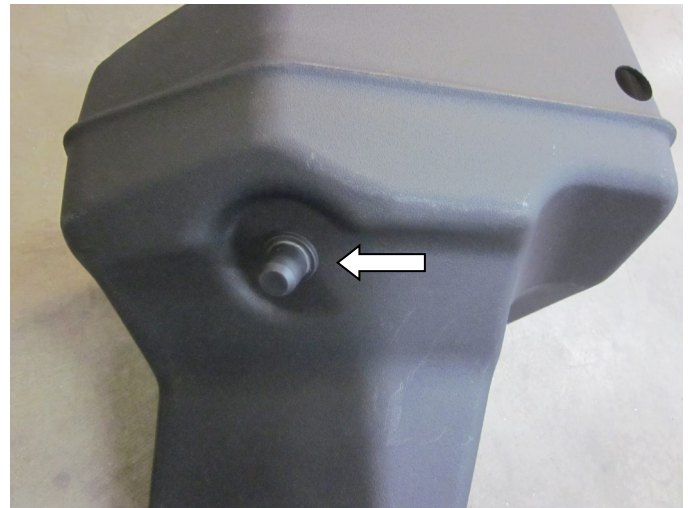

b) Install the rubber bushing removed in step 2h) onto the aluminum threaded boss installed in step 3a).

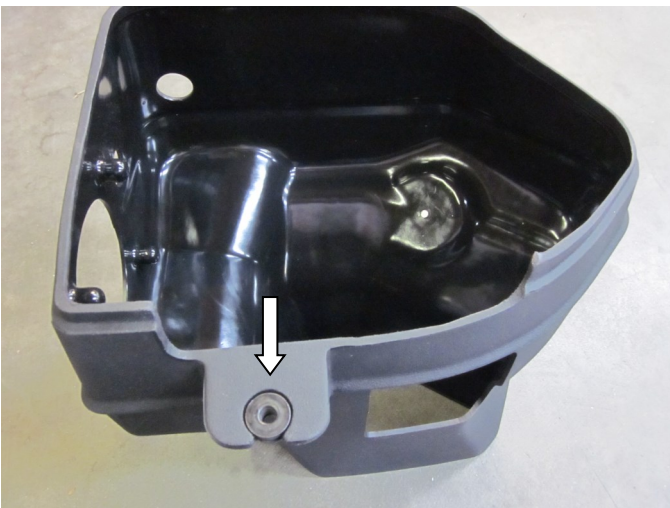

c) Install the rubber grommet removed from step 2i) into the tab on the MOPAR air box.

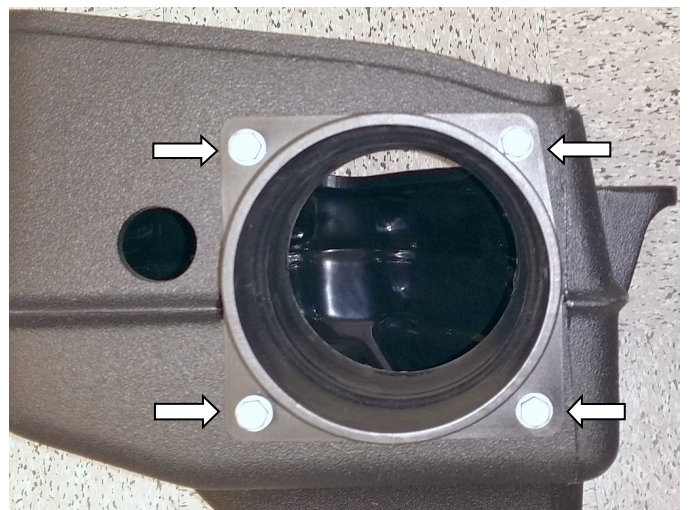

d) Attach the air filter adaptor tube to the MOPAR air box with the supplied M6 bolts using red threadlocker and tighten to 3.5Nm (31 in/lb).



INSTALLATION INSTRUCTIONS
AIR INTAKE KIT
2011-2016 DODGE CHALLENGER 6.4L HEMI
2012-2016 CHRYSLER 300C 6.4L HEMI
2012-2016 DODGE CHARGER 6.4L HEMI
PART NUMBER 77070043AC

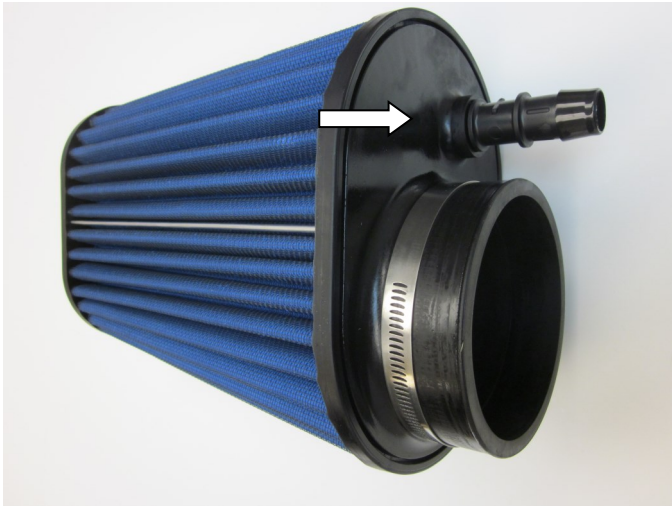

e) Install the supplied hose adaptor fitting into the 3/8" hole next to the air filter flange.

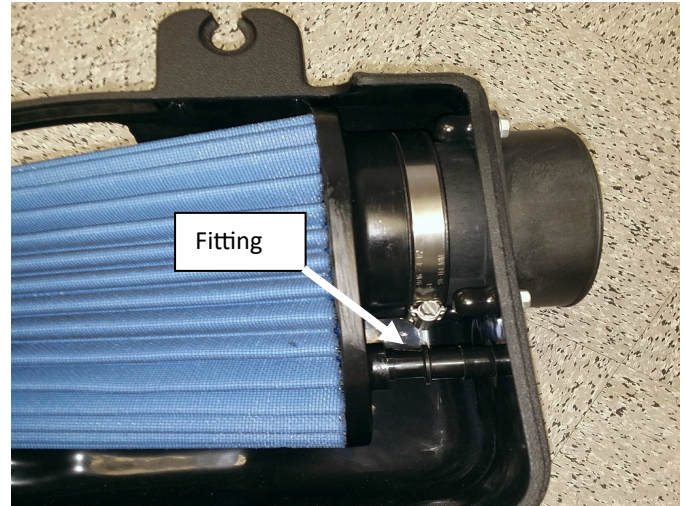

f) Secure the air filter to the air filter adaptor tube in the MOPAR air box with supplied hose clamp. Be sure to align the hose adaptor fitting to the hole in the air box.

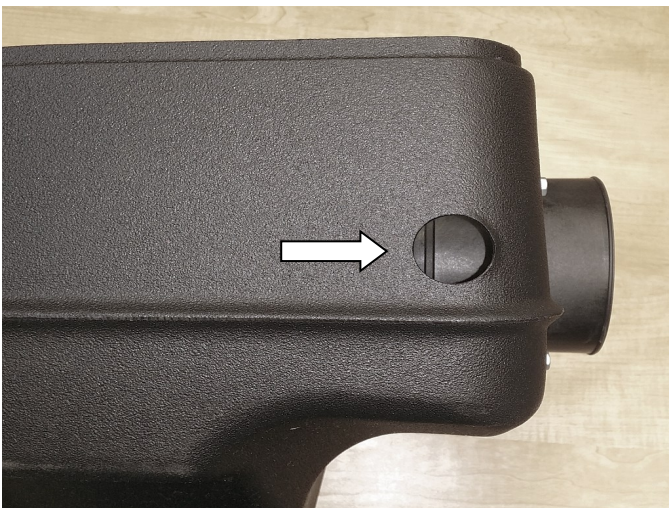

g) Install the supplied blanking plug into the unused hole on the side of the air box.

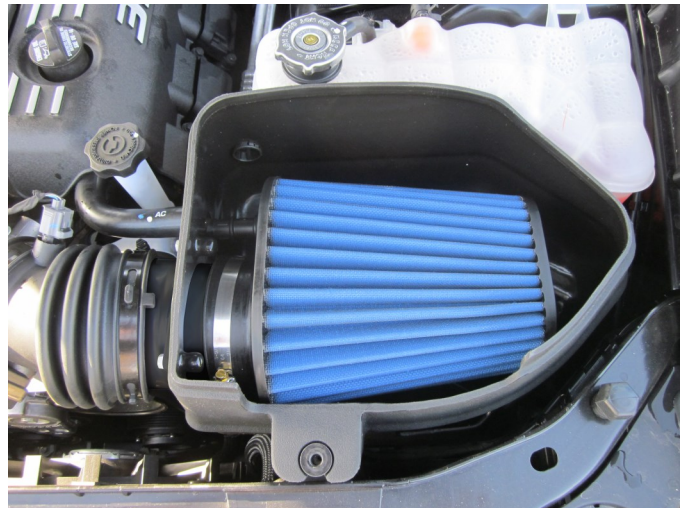

h) Lower the complete MOPAR air box assembly into the engine bay. **Note: Make sure the bottom of the air box and the rubber bushing is seated to the inner fender.**



INSTALLATION INSTRUCTIONS
AIR INTAKE KIT
2011-2016 DODGE CHALLENGER 6.4L HEMI
2012-2016 CHRYSLER 300C 6.4L HEMI
2012-2016 DODGE CHARGER 6.4L HEMI
PART NUMBER 77070043AC

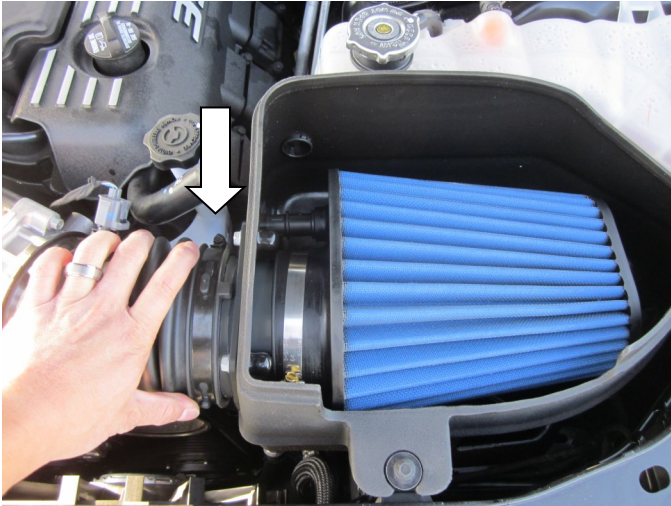

i) Align the air filter adaptor tube to the factory air inlet tube.

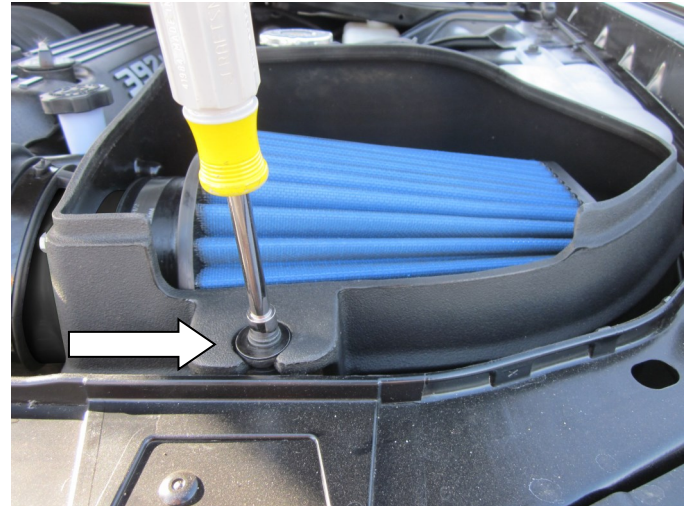

j) Secure the MOPAR air box to the core support with the factory M6 bolt removed in step 2f) and tighten to 3.5Nm (31 in/lb).

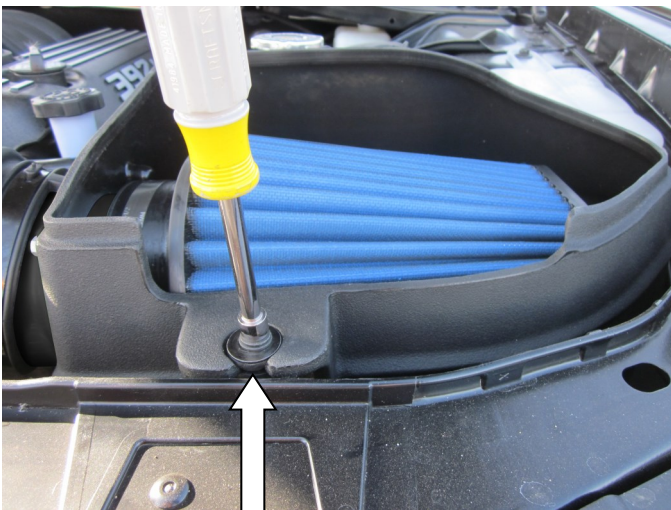

k) After checking clearances and alignment, tighten the hose clamp on the factory air inlet hose to 3.0Nm (26.5 in/lb).

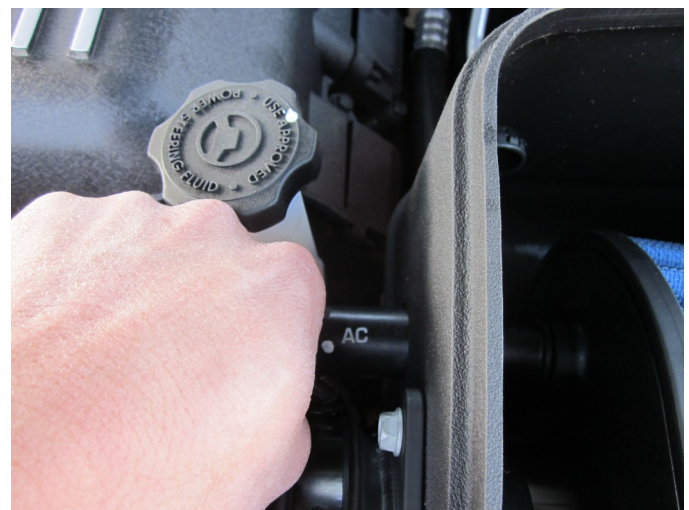

l) Attach the factory vent hose to the hose adaptor from the air filter that was removed in step 2c).



INSTALLATION INSTRUCTIONS
AIR INTAKE KIT
2011-2016 DODGE CHALLENGER 6.4L HEMI
2012-2016 CHRYSLER 300C 6.4L HEMI
2012-2016 DODGE CHARGER 6.4L HEMI
PART NUMBER 77070043AC



m) Attach the supplied rubber edge trim to the top of the air box.



n) Edge trim installed.



o) This is how your MOPAR air intake system should look when properly installed.



INSTALLATION INSTRUCTIONS
AIR INTAKE KIT
2011-2016 DODGE CHALLENGER 6.4L HEMI
2012-2016 CHRYSLER 300C 6.4L HEMI
2012-2016 DODGE CHARGER 6.4L HEMI
PART NUMBER 77070043AC

4) Re-assemble the vehicle

- Inspect all MOPAR air intake kit components proximity to A/C lines, dip sticks, hoses for ample clearance.
- Tighten all fasteners to 3.5Nm (31 in/lb) and hose clamps to 3.0Nm (26.5 in/lb).**
- Inspect the engine bay for any loose tools, and then check that all fasteners are tight, and that the IAT sensor cable is properly connected.
- Start the engine and allow it to idle, and then perform a final inspection before driving the vehicle.

5) Cleaning Instructions: MOPAR DRYFLOW Air Filter

(It is recommended that you service your MOPAR air filter every 20,000 miles for optimum performance.)

- Remove the air filter from intake system and set the filter clamp aside.
- Measure the length of the filter media.
- Fill a pail with warm clean water to the depth determined in Step B. Add a mild household detergent or DRYFLOW air filter cleaning solution to the water.
- Without allowing the solution to flow into the filter neck, submerge the filter into the water and let it soak for 10 minutes. After soaking, rotate the filter back and forth to agitate the water and knock off dirt.
- Empty the bucket of dirty water. Repeat steps C and D.
- Refill the pail with clean warm water and rinse by rotating the filter as in step D. The water should be clear with no signs of dirt in the pail.
- Allow the filter to air dry. Re-install the filter on the intake system once it is dry.

DO NOT APPLY ANY OIL TO THIS FILTER.

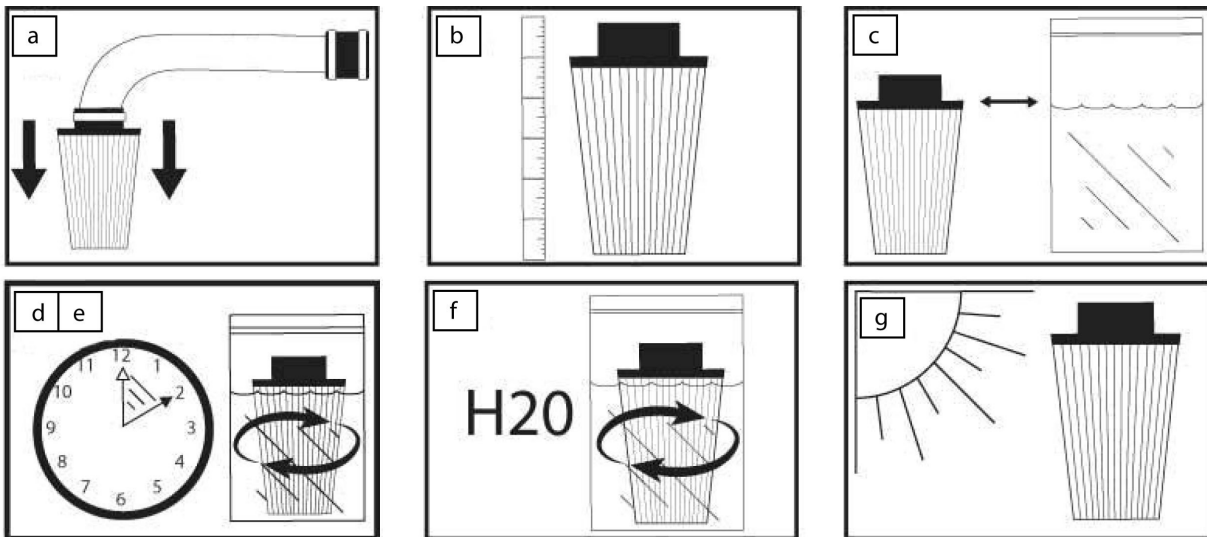

OEM-DOD300
11/16/2015